



The care your baby deserves



Introduction

Optimal is a reputable European corporation that supplies a range of health and baby care products to the pharmaceutical and retail industry globally.

Founded in 2006, the company initially aimed to meet the basic needs of mothers and babies. As it grew, Optimal's commitment to satisfaction, integrity, and diversity helped it establish a strong client base. Through clinical trials and research, Optimal's products have proven to be effective in promoting overall well-being and caring for elders and children. Our products adhere to the strict standards set by the FDA and undergo meticulous testing before delivery. We use only materials that are free from harmful toxins such as BPA, paraben, phthalate, and phenoxyethanol. Choosing our brand ensures superior quality products for you and your family.

Today, Optimal offers the largest selection of products under one brand and is recognized worldwide in the medical supplies field with a presence in over 18,000 pharmacies. Optimal has become the go-to destination for such items.

Visit www.optimalmedics.com to learn more about Optimal and experience quality care that's comfortable, affordable, and excellent.

TABLE OF CONTENT



BREASTFEEDING

Manual Breast Pumps	6
Breast Milk Storage bags	7
Electric Breast Pumps	8 - 9
Breast Pump Kit & Breast Milk Collector	10
Ultra Soft Breast Pads	11
Nipple Protector	11

PREGNANCY & BABY PILLOWS

BABY PLAYPENS & MATTRESSES

BABY MONITORING

FEEDING BOTTLES

SILICONE NIPPLES

DIGITAL STEAM STERILIZER & DRYER

BABY BOTTLE CLEANSER

ACCESSORIES (Baby Care Products)

BABY DIAPERS

FEEDING PRODUCTS

Table-ware Feeding Set	65 - 66
Water Cups	67 - 71

SKIN CARE PRODUCTS

Baby Toiletry Products	73
Sunscreen Products	73
Nappy Change Cream	73

5 - 11

12 - 14

15 - 18

19 - 28

29 - 37

37 - 38

39 - 40

41

42 - 54

55 - 63

64 - 71

72 - 73

DENTAL CARE

BABY BATH ACCESSORIES

BABY CARRIERS

BABY ON THE MOVE

MARKETING SUPPORT

74 - 76

77 - 80

81 - 83

84 - 90

91 - 93

ICON INDEX



Regular Flow



Medium Flow



Safe to use



Easy Milk Extraction



Adjustable & Comfortable



0 - 6 months



4 - 12 months



6 - 18 months



10 - 24 months



from one year and above



0% Bisphenol A
(BPA FREE)



Liquid Silicone



Paraben Free



Breastfeeding is widely known to have numerous benefits for babies. Doctors recommend breast milk as the ideal source of nutrition for the baby's first year, supplemented with solid food after 6 months.

BREASTFEEDING

However, modern mothers often have to balance breastfeeding with other responsibilities and may wish to involve other family members in feeding the baby. To address these challenges, Optimal has developed a range of breast pumps that make breastfeeding simpler, more comfortable, and ideal for busy mothers.



Manual Breast Pumps

- The Optimal breast reliever is a one-handed solution for breastfeeding mothers who are experiencing engorgement or swelling in their breasts.



OPB - 1052

Silicone Squeezable Breast Pump

(Special Shape closely as possible to breast-feeding)

Adaptable to any breast size, increases the flow of milk and prevents the inflammation of mammary glands during milk extraction.

- ✓ 100% food grade silicone & BPA free, non-toxic, odorless
- ✓ One-integrated design

INSTRUCTIONS:

- Squeeze the silicone ball continuously to extract milk from breast.
- In the mean time, massage the breast to make the milk flowing out easier.



OPB - 1059



Natural-Fit Manual Breast Pump

The breast pump combo set from Optimal allows for expressing, storing, transporting, and feeding breast milk. It features:

- a soft comfort massaging breast cup
- a silicone massage cushion inside the horn to create a soft and natural feel
- is compatible with Optimal's standard wide neck bottle.



OPB - 1080



Breast Milk Storage Bags

- 200ml +
- Leak-proof design
- Stand-up base
- Writable label area
- Capacity markings
- Heavy-duty, freezer-safe material
- Protects and stores your breastmilk
- BPA-free made from food-grade plastic
- With a pour spout to transfer milk easily



Small Caliber, easy pour out

OPB - 1079

30 BAGS



Suitable for freezing



Do not boil



Do not microwave

SELF STANDING BAG

Breast Milk Storage Bags

- 200ml +
- Leak-proof design
- Stand-up base
- Writable label area
- Capacity markings
- Heavy-duty, freezer-safe material
- Protects and stores your breastmilk
- BPA-free made from food-grade plastic
- With a pour spout to transfer milk easily



Small Caliber, easy pour out

OPB - 1179

☆ 50 + 10 FREE



Suitable for freezing



Do not boil



Do not microwave

SELF STANDING BAG



Single Electric Breast Pump



OPB - 1305

Wearable Electric Breast Pump



OPB - 1270

HANDS FREE

	OPB - 1305	OPB - 1270
Pump	Single	Single - Wearable
Noise	Low noise	Low noise
Function	10 levels massage 3 degrees for frequency 15 levels for suction	9 levels massage 9 levels for suction
Battery	Rechargeable	Rechargeable
Screen	LCD	LCD
Power	A/C adapter or USB cable	USB cable
Screen	Non touch	Non touch
Timer	30 mins	30 mins
Cushion insert	24mm	15mm, 17mm and 21mm, 25mm



Easy Milk Extraction



Safe to use



Adjustable & Comfortable



0% Bisphenol A



Material: liquid silicone

Double Electric Breast Pump



OPB - 1268

Double Motor Electric Breast Pump



OPB - 1269

Hospital
Recommended

	OPB - 1306	OPB - 1268	OPB - 1269
Pump	Single	Double	Double
Motor	Single motor	Single motor	Double motor
Comfort	Maximum comfort	Maximum comfort	Maximum comfort
Function phases	3 phases	3 phases	4 phases
Vacuum Control	9 levels	9 levels	9 levels
Speed control	5 levels	5 levels	5 levels
Backflow	Ant-backflow system	Ant-backflow system	Ant-backflow system
Breast Shield	Soft	Soft	Soft
Noise	Low noise with mute button	Low noise with mute button	Low noise with mute button
Touch buttons	Touch control with child lock	Touch control with child lock	Touch control with child lock
Operation	Single	Single	Left, right or duet operation
Cushion insert	15,17 and 21mm	15,17 and 21mm	15,17 and 21mm

Single Electric Breast Pump

Total Power: 10W
 Noise: <50 dB
 Power Source: mains or battery
 AC/DC Power adapter:
 Input: 100~240V ~ 50/60Hz
 Output: 5V/2A



RECHARGEABLE
BATTERY



MEMORY
FUNCTION



PAUSE
FUNCTION



OPB - 1306

Breast Pump Kit

Available in 2 sizes:
- 24 mm cushion
- 27 mm cushion



OPB - 1261

OPB - 1262

What's In The Box?

- 1 - Milk Bottle
- 2 - Bottle Lid
- 3 - Bottle Stand
- 4 - Valve
- 5 - Breast Shield Body
- 6 - Diaphragm
- 7 - Diaphragm cap
- 8 - Silicone Cushion
- 9 - Dust Cover
- 10 - Y Connector

- 11 - Main Tube
- 12 - Tubing x 1 set
- 13 - Spare membrane x 5 pcs

- Compatible with Optimal Breast Pumps
- Soft breast shield
- Hygienic replacement Kit
- Safe Material

Silicone Breast Milk Collector

Collect every precious drop while saving the flowing milk from the other breast during breastfeeding.

- Collects leaking milk
- Protects your nipple
- Lightweight and easy to wear
- With a ventilation vent
- Pouring hole design
- Safe Cleaning

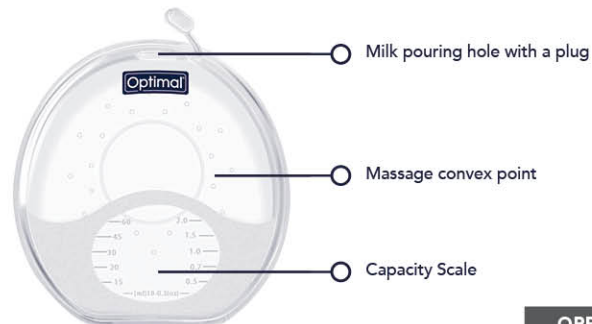

OPB - 1260

BREAST MILK STORAGE RECOMMENDATIONS

Up to 4 hours
Room temperature
(25 degrees or colder)

Up to 4 days
Fridge
(4 degrees or colder)

Up to 6 months
Freezer
(-18 degrees or colder)

Precautions:

1. Perform boiling disinfection for 3-5 minutes before the first use, and avoid direct contact with the inner wall of the sterilizer for all parts. Please clean and disinfect thoroughly before and after each use. It is recommended to use Optimal sterilizer for disinfection.
2. Do not clean this product with sharp sanitary ware to avoid damage; and avoid wearing it for a long time to avoid discomfort. Pour out the collected breast milk in time.
3. Keep the milk spout in an upward position during use and refrain from using it while lying down.
4. We recommend removing the shells every two hours to allow the nipple to dry completely.

Ultra Soft Breast Pads

Designed for ultra absorbency, reliability & superior comfort

- 1- Super absorbent layer keeps moisture from leaking onto clothes
- 2- Contour shape, each pad is contoured for the perfect fit
- 3- Double adhesive securely holds pad in place
- 4- Breathable, natural materials are hygienic and soft
- 5- Individually wrapped for cleanliness and portability



Hygienic and antibacterial



Super absorbent



Maximum breathability

30 SOFT BREAST PADS



OPB - 1050

Ultra Soft Breast Pads

Designed for ultra absorbency, reliability & superior comfort

- 1- Super absorbent layer keeps moisture from leaking onto clothes
- 2- Contour shape, each pad is contoured for the perfect fit
- 3- Double adhesive securely holds pad in place
- 4- Breathable, natural materials are hygienic and soft
- 5- Individually wrapped for cleanliness and portability



Hygienic and antibacterial



Super absorbent



Maximum breathability

60 SOFT BREAST PADS



OPB - 1051

★ 50 + 10 FREE

Nipple Protector

to help continue breastfeeding

Made of ultra-fine, soft, odorless, taste-free silicone, protect sore or cracked nipples during breastfeeding.

- Easy sterilization
- Help & protect mother from pain and inflammation.



OPB - 1170

Small (12mm)



OPB - 1171

Medium (14mm)



OPB - 1172

Large (16mm)



PREGNANCY & BABY PILLOWS

Optimal pillows meet your needs during pregnancy, breastfeeding, and postpartum phase for you and your baby.

Nursing Pillow For Breastfeeding



MEMORY FOAM

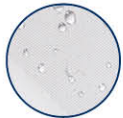

WATERPROOF LINER



MACHINE WASHABLE
REMOVABLE COVER

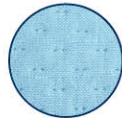

BREATHABLE FABRIC

ULTIMATE COMFORT DESIGN

This nursing pillow is designed to provide ultimate comfort for your arms and back, ensuring a soothing experience during breastfeeding, bottle feeding, and bonding sessions. It elevates your baby to an ergonomically correct position, promoting better posture and reducing strain.

VERSATILE OPTIONS

Featuring a C-shaped design, this pillow provides versatile support for your newborn throughout their entire first year. It can be used for propping, tummy time, sitting, and even exploring their fingers and toes. It is specifically designed for your baby's supervised awake time, enhancing their developmental activities.

DESIGNED FOR ALERT TIME

It's important to note that this product is intended for supervised awake time purposes, such as feeding and bonding moments. It is not intended for use during sleep as it focuses on enhancing interaction and engagement between you and your baby.

Pregnancy Wedge Pillow



OPB - 1234



MEMORY FOAM



ERGONOMIC WEDGE
DESIGN



SUPPORTS BABY
BUMP



EASES DISCOMFORT
DURING PREGNANCY



RELIEVES
BACK PAIN

IT HELPS RELIEVE PREGNANCY DISCOMFORT for pregnant women in any trimester. Use the pillow to support the belly, back, or knee.

HIGH-QUALITY MEMORY FOAM and versatile design make this an all-around essential maternity wedge pillow. It is an ideal choice if you are seeking back support, or even want to prevent yourself from rolling onto your baby bump while you sleep.

ADEQUATE BELLY SUPPORT HELPS REDUCE SWELLING in your hands, legs, and feet by improving circulation and relieving pressure and stress. Open-cell memory foam promotes airflow and ventilation to help you stay cool and comfortable all night long.

WASHABLE COVER includes a super soft and breathable cotton pillow cover that is zipper-removable and machine-washable.

3 In 1 Baby Crib Wedge Anti Reflux Pillow

0 m.



OPB - 1235



ANTI REFLUX - ANTI COLIC

Safely Elevates Baby's Head: This pillow is designed to provide a gentle incline, supporting the head of the baby while they sleep. This elevation can help with issues like congestion, acid reflux, or breathing difficulties by promoting better airflow.



Lift the back side cover

MEMORY FOAM

Insert the small pillow

Breathable Kids Pillow



OPB - 1236



SUPER SOFT & COMFORTABLE

The airflow fabric draws away moisture and increases air circulation, creating a safe sleep environment for your toddler even during hot, humid nights. Scientifically proven to help prevent the flat head syndrome, with a removable & machine washable cover and wipe-clean foam filling, it's the perfect pillow for your child.



MACHINE WASHABLE
REMOVABLE COVER



MEMORY FOAM



BREATHABLE FABRIC

Newborn Baby Pillow With Crown Design



OPB - 1237

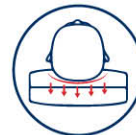

The newborn head-shaping pillow is ergonomically designed to distribute pressure evenly over the skull, providing full support for the baby's head and neck. It can protect your newborn baby's delicate head and spine growth during this crucial time of development.



Our anti-flathead pillow serves as a sleep positioner, aiming to reduce the occurrence of flathead syndrome, plagiocephaly, brachycephaly, and torticollis. The thin and small anti-roll headrest is specifically designed for daily use.



BABY PLAYPENS

Optimal baby playpens and cribs are the perfect solution for parents who want safety and quality at once.

Easy-fold design, with very compact folded position for storage convenience.

Baby Playpen - 0 Months to 13 Kg



Rounded Corners For Safety



2 Wheels With Brakes



Soft & comfortable fabric

Zipper Opening For Fun Play

2 mesh sides so you can always observe your child



- Lightweight
- Safe and durable
- Mattress with 2 levels
- Stable, with 2 wheels
- With mosquito net
- Safe for playing
- Easy to install and fold

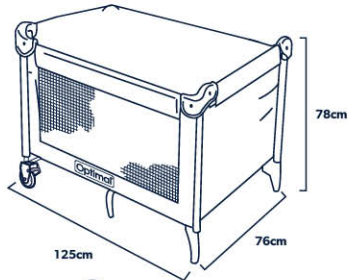

OPB - 1240



Compact Folding

Baby Playpen - 0 Months to 13 Kg



Rounded Corners For Safety



2 Wheels With Brakes



Soft & comfortable fabric

Zipper Opening For Fun Play

2 mesh sides so you can always observe your child



- Lightweight
- Safe and durable
- Mattress with 2 levels
- Stable, with 2 wheels
- With mosquito net
- Safe for playing
- Easy to install and fold

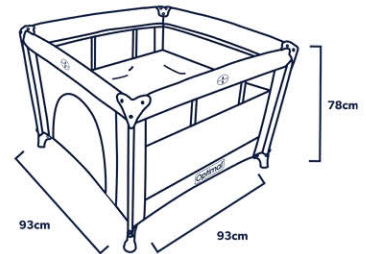

OPB - 1241



Compact Folding

Rocking Baby Crib - 0 to 6 Months



Net to protect your baby from mosquito



Deluxe and lightweight aluminium frame



Attach the mesh tent on top of the bassinet and push the snap button on the sides to keep it in place.

2 mesh sides so you can always observe your child

Soft & Comfortable Fabric

Rocking Function

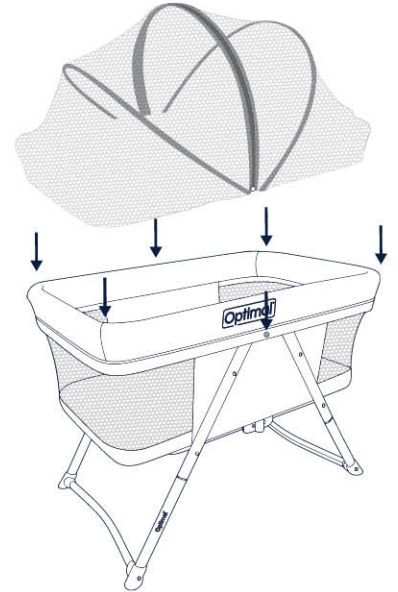

- Features a rocking function designed to soothe your baby
- Equipped with mesh fabric to enhance airflow and ensure you can always observe your baby
- Designed for easy assembly
- Conveniently folds in one step
- Stands freely when folded
- Includes a mosquito net
- Includes a mattress pad and carry bag
- Ideal for travel due to its portability and convenience
- Maximum weight: 8kg

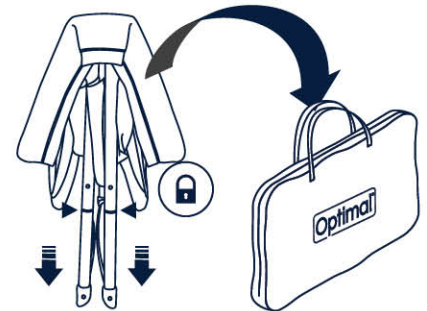
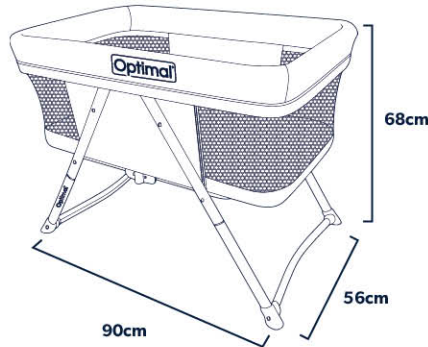

OPB - 1242



BABY MATTRESSES - HIGH QUALITY, SOFT & DURABLE

Optimal® baby mattress is a specially designed sleeping surface for infants that prioritizes firmness and safety. It is typically made from high-density foam or innersprings, offering a flat, firm surface that prevents suffocation by ensuring the baby's face does not sink into the material.

Key safety standards require a snug fit within the crib to eliminate dangerous gaps, giving parents peace of mind during their child's sleep.



OPB - 1245

W: 47 CM X L: 85 CM

FOR OPB - 1242 CRIB



OPB - 1244

W: 86 CM X L: 86 CM

FOR OPB - 1241 PLAYPEN



OPB - 1243

W: 65 CM X L: 115 CM

FOR OPB - 1240 PLAYPEN



BABY MONITORING

It's essential to constantly track you baby's fever, weight, and sleep at all times. Find out more with Optimal's monitoring products.

Video Baby Monitor

3.7" Video Baby Monitor - HD 720P

- 6 Lullabies
- 4x Digital Zoom
- Intercom Calling
- 3.7" LCD Screen
- Infrared Night Vision
- VOX Sound Detection
- Breastfeeding Reminder
- LCD Supports 4 Cameras
- Room Temperature Alarm
- Two-Way Communication

720P



LULLABIES

Keep an eye on your little one with ease using Optimal® Digital Video Baby Monitor with built-in night light and LCD screen. Soothe your baby with a selection of lullabies and gentle sounds played directly from the baby unit. Monitor the nursery temperature at a glance, conveniently displayed on the LCD screen to ensure your baby's comfort. Plus, with automatic infrared night vision, you can check in during naps or nighttime—giving you peace of mind around the clock.

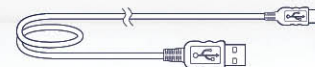

OPB - 1403

Type C power supply 5V x 2 cables + 2 adaptors

Digital Audio Baby Monitor

Sound level indicator

- LCD Screen
- Low Emissions
- Lullaby
- Two Way Talk
- Night Light
- Out of range and temperature alarm
- No wifi required
- Sound and vibration mode
- 2 USB cables work with any smartphone adapter



LULLABY



OPB - 1401

Digital Audio Baby Monitor

- Low Emission Radio • Baby Feeding Alarm
- Music Lullabies • Starry Night Light

0m+

SAFE DIGITAL AUDIO BABY MONITOR

Low Emission Radio



- ULTRA LOW RADIATION
- Patented Zero Emission Wireless Technology
- Over 60 Hours of Usage on a Single Charge
- Zero Transmission Delay
- Real Time Transmission up to 650 meters
- Baby Feeding Alarm
- Starry Night Light
- White Noise Silencer
- Music Lullabies
- Two Way Communication
- Temperature Sensor



 SAFE DIGITAL AUDIO

OPB - 1400

Height & Weight Baby Scale | 25 Kg Capacity

Comprehensive health monitor for babies!

ALL-IN-ONE
DIGITAL
BABY SCALE



- Ergonomic cradle designed platform
- Infant height measurement with extensible/adjustable platform length
- Maximum 8 users supported, history data review
- Measurements comparison versus previous results
- Easy to read extra large display for height & weight
- Zero button subtracts the weight of diapers or clothing
- Equipped with auto-off technology to conserve battery life



OPM - 1329

PREHEAT Ear Thermometer

- 360° flexible probe
- Preheating sensor technology
- Night mode: Silent temperature measurement with night light
- Age mode: Can be used by babies, children and adults
- Stores 32 sets of memories
- 20 individually packed probe covers
- Probe cover automatically ejected

SPECIFICATIONS	OPB - 1366
Measurement	Body temperature
Mode	Contact type
Alert	Fever alert colors
Memory	32 measurements
LCD	3 colors
Unit	Celsius & Fahrenheit
Automatic power off	60 seconds
Result	in 1 second



OPM - 1366

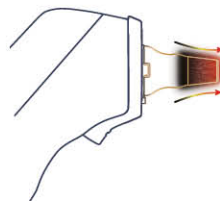

THE PREHEAT SENSOR TECHNOLOGY
LOWER THE COOLING EFFECT AND
PROMOTES ACCURACY



OPM - 1367



Flexible probe



Night mode

CONTAINS

- Ear Thermometer 1pc
- Thermometer Case 1pc
- Instruction Manual 1pc
- Quick Reference Guide 1pc
- AA alkaline Battery 2pcs
- Probe Cover 20pcs (1 box)



Prevents cross infection

x20
Probe Covers

Super thin for accurate readings

EAR, FOREHEAD Infrared Thermometer

- Accurate results
- 1 second testing
- Easy to use with 1 single button
- 2 operating modes: Ear and forehead
- Stores the last recorded result
- Three-color backlight to indicate the temperature range
- Ability to switch between Celsius and Fahrenheit display
- Automatic shut-off after 35 seconds to conserve battery life
- Practical, easy to use

SPECIFICATIONS	OPB - 1364
Measurement	Body temperature
Mode	Infrared detection system
Alert	Fever alert colors
Memory	1 last measurement
LCD	3 colors
Unit	Celsius & Fahrenheit
Automatic power off	35 seconds
Result	in 1 second



Ear mode



Forehead mode



Green

Normal Temperature



Yellow

Mild Fever



Red

High Fever



OPM - 1364

DESIGNED FOR THE WHOLE FAMILY

Non-Contact Infrared Thermometer 6 in 1

	OPB - 1336	OPB - 1327
Measurement	Body, surface & room temperature	Body, surface & room temperature
Mode	Infrared detection system	Infrared detection system
Alert	High temperature alert	High temperature alert
Memory	32 measurements	32 measurements
LCD	3 colors	3 colors
Unit	Celsius & Fahrenheit	Celsius & Fahrenheit
Automatic power off	30 seconds	30 seconds
Reading	100.000	40.000
Result	in 1 second	in 1 second



10°C ~ 40°C
(50°F ~ 104°F)



Place in the measurement environment for 20 minutes



Wipe any sweat



No gear



Aim at the side of forehead



3~5cm
(1.2~2in)

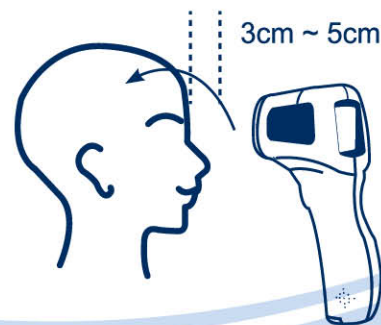

- Aim the thermometer probe at the side of the forehead.
- Keep the distance between 3cm-5cm.
- Wipe any perspiration from the forehead



Non-contact measuring

Fixed & Flexible Digital Thermometers

Fixed Tip

30 Sec.(24/display)



OPM - 1332

Flexible Tip

30 Sec.(24/display)



OPM - 1331

Flexible

30 Sec. (24/display)



OPM - 1333

Flexible

60 Sec. (24/display)



OPM - 1330



ELECTRIC Nasal Aspirator

- Clears baby's nasal passages, quickly and gently
- Easy To Clean
- Rechargeable Battery
- Compact And Portable
- Adjustable Suction Levels
- 2 Soft Silicone Suction Nozzles

CAN BE USED FOR BABIES, AND CHILDREN



2 suction levels
Up to 68kPa



2 soft silicone
suction nozzles

2 SOFT SILICONE TIPS IN DIFFERENT SIZES

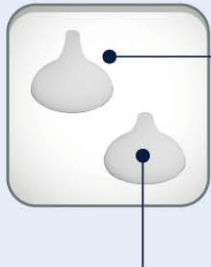

1 - Narrow nozzle
(recommended when the mucus
is in liquid form and baby's
nostrils are narrow)

2 - Large nozzle (recommended
when the mucus is in solid form
and baby's nostrils are large)



OPB - 1405

Optimal nasal aspirator allows you to easily and safely clear your baby's nose for clearer breathing, easier feeding, and better sleep. Removing excess mucus also helps prevent further complications such as coughs, ear infections, and tummy upsets.

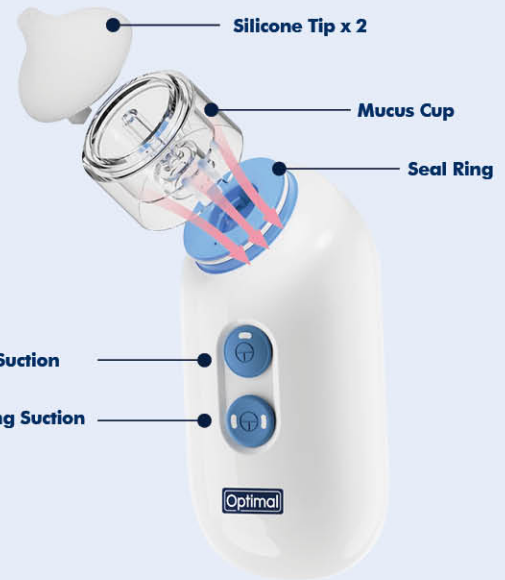

Fast and gentle
relief for nose



2 Suction
levels



Anti-Overflow
& Anti-Backflow



IP22 Waterproof
& dustproof



Type-C
cable



Safe for
infants



FEEDING BOTTLES

Optimal's Well-Being feeding bottles are designed with your baby's safety and your preferences in mind. They come in various sizes and materials, all free from BPA (bisphenol A) to ensure compliance with safety standards and meet the taste preferences of all mothers.

MAMILLA BOTTLES



IDENTICAL SHAPE TO MOMMY'S BREAST

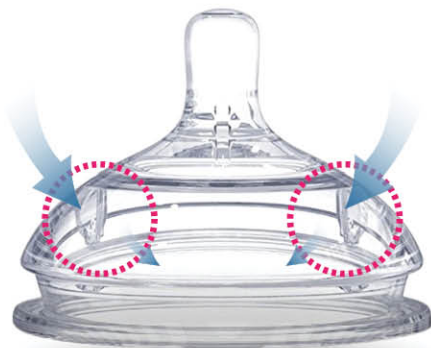

2 Levels of Flow available:

- Slow Flow (0-6 months)
- Medium Flow (6-18 months)

DOUBLE ANTI-COLIC SYSTEM



AIR FLOW

AIR FLOW

OPTIMAL'S new improved slow and medium Flow Wide Neck nipple features a unique vertical and horizontal double-venting system that effectively reduces colic and prevents the nipple from collapsing



Extra Wide Neck Feeding Bottles | Mamilla Bottles Natural Nipple



Specially designed teat structure encourages sucking and ensures comfortable feeding.

210 ml P.P. Extra Wide Neck Feeding Bottle



OPB - 1090



300 ml P.P. Extra Wide Neck Feeding Bottle



OPB - 1092



210 ml P.P. Extra Wide Neck Feeding Bottle With Handle



OPB - 1091



300 ml P.P. Extra Wide Neck Feeding Bottle With Handle



OPB - 1093



Special Nipples With Anti-Colic Air Exchange System

AIR EXCHANGE SYSTEM

The air exchange system enables babies to drink continuously and swallow liquid instead of air, ensuring comfortable feeding.

Anti-colic valve system

The anti-colic valve system on Optimal's teat allows air to enter the bottle instead of your baby's tummy, ensuring comfortable feeding and reducing the risk of colic.

Highly durable

This BPA-free bottle (0% Bisphenol A) is made of PP material for extra durability and ease of cleaning.

Fit your baby's growing needs

Round and Orthodontic teats are available.

IMPORTANT:

Use only optimal teats with optimal bottles

Advanced
Orthodontic
Nipple



Round
Nipple



One Piece
ANTI-COLIC
Air System



Narrow Neck Water Feeding Bottle With Round Nipple



60 ML P.P. WATER SPECIAL FEEDING BOTTLE

0
m.

OPB - 1028

NON-TOXIC
BABY BOTTLES



Narrow Neck Feeding Bottle With Round Nipple



Specially designed teat structure encourages sucking and ensures comfortable feeding.

140 ml P.P. Slim Waist Feeding Bottle

0 m⁺

OPB - 1025



240 ml P.P. Slim Waist Feeding Bottle

6 m⁺

OPB - 1026



140 ml P.P. Slim Waist Feeding Bottle With Handle

0 m⁺

OPB - 1029



240 ml P.P. Slim Waist Feeding Bottle With Handle

6 m⁺

OPB - 1027



Narrow Neck Feeding Bottle With Orthodontic Nipple



Specially designed teat structure encourages sucking and ensures comfortable feeding.

140 ml P.P. Orthodontic Feeding Bottle



OPB - 1024



240 ml P.P. Orthodontic Feeding Bottle



OPB - 1023



140 ml P.P. Orthodontic Feeding Bottle With Handle



OPB - 1021



240 ml P.P. Orthodontic Feeding Bottle With Handle



OPB - 1022



Wide Neck Feeding Bottle



Specially designed teat structure encourages sucking and ensures comfortable feeding.

180 ml P.P. Wide Neck Feeding Bottle

0 m⁺

OPB - 1034



240 ml P.P. Wide Neck Feeding Bottle

6 m⁺

OPB - 1032



300 ml P.P. Wide Neck Feeding Bottle

6 m⁺

OPB - 1030



180 ml P.P. Wide Neck Feeding Bottle With Handle

0 m⁺

OPB - 1035



240 ml P.P. Wide Neck Feeding Bottle With Handle

6 m⁺

OPB - 1033



300 ml P.P. Wide Neck Feeding Bottle With Handle

6 m⁺

OPB - 1031



Extra Wide Neck Feeding Bottles



Specially designed teat structure encourages sucking and ensures comfortable feeding.

150 ml PP Extra Wide Neck Feeding Bottle

0 m⁺

OPB - 0101



150 ml PP Extra Wide Neck Feeding Bottle With Handle

0 m⁺

OPB - 0103



240 ml PP Extra Wide Neck Feeding Bottle

6 m⁺

OPB - 0102



240 ml PP Extra Wide Neck Feeding Bottle With Handle

6 m⁺

OPB - 0104



Heat Resistant Glass Feeding Bottle

Made of pure borosilicate glass. Resistant to sudden temperature changes.

Optimal's glass baby bottles are BPA-free, lead-free, and do not contain any harmful substances to the human body. The bottles are clear, sparkling, and smooth with no water or mold wrinkles. The smooth inner body makes them easy to clean.



6 m⁺

OPB - 1095
240 ml

OPB - 1098
240 ml

OPB - 1097
120 ml



0 m⁺



OPB - 1094

160 ml

OPB - 1078

60 ml

Silicone Nipples



Optimal offers a diverse selection of silicone nipples for babies, which are ideal for use during breastfeeding or when nursing is not possible. These anti-colic nipples are available in a range of shapes and flows to suit your baby's needs.

REGULAR SILICONE NIPPLES:

These BPA-free nipples are made of transparent food grade silicone. Heat resistant, non-toxic and odorless. (2 pieces/blister card)

ORTHODONTIC SILICONE NIPPLES:

The shape mimics the mother's breast during suction. (2 pieces/blister card)

NARROW SMALL NECK NIPPLES

REGULAR SILICONE NIPPLES

ORTHODONTIC SILICONE NIPPLES



OPB - 0373

OPB - 0359

OPB - 1055

OPB - 1041

WIDE NECK SILICONE NIPPLES

REGULAR SILICONE NIPPLES

ORTHODONTIC SILICONE NIPPLES



OPB - 1064

OPB - 1065

OPB - 1039

OPB - 1049

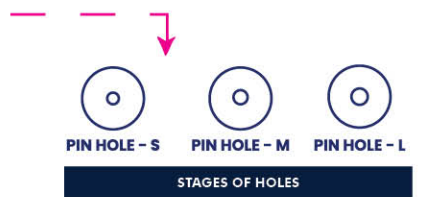

- **Slow Flow (XS - 0.2mm)** with a small hole for newborn babies up to 3 months.
- **Small Flow (S - 0.3mm)** larger hole for babies 3 to 6 months.
- **Medium Flow (M - 0.4mm)** largest hole for babies 6 months and up.
- **Fast Flow (L - 0.6mm)** largest hole for babies 9 months and up.
- **Fast Flow (XL - 0.8mm)** largest hole for babies 12 months and up.



OPB - 1161

XS
0.2mm



Slow Flow



OPB - 1162

S
0.3mm



Small Flow



OPB - 1163

M
0.4mm



Medium Flow



OPB - 1164

L
0.6mm



Fast Flow



OPB - 1165

XL
0.8mm



Fast Flow

With a wider base, used for wide-neck bottles to help avoid nipple confusion among breast-fed babies. Made with 100% liquid silicone material, the softest choice for baby's comfortable feeding.

Ultra-safe, Non-toxic: 100% BPA-Free, No Phthalates.

Designed to grow with your baby:
wide-neck silicone nipples in different flow speeds, to
match your baby's age and feeding needs.

SOFT SILICONE NIPPLE

Soft & patented silicone surface provides a familiar drinking feeling.

SYMMETRIC SHAPE

Nipple always fits perfectly in baby's mouth.

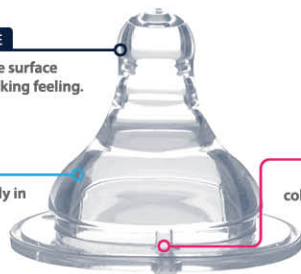

AIR VALVE

Prevents the nipple from collapsing, and allows for an even milk flow.

EXTRA WIDE SILICONE NIPPLES

REGULAR SILICONE NIPPLES



OPB - 0114



OPB - 0115

DOUBLE ANTI-COLIC SYSTEM



OPB - 1060



OPB - 1062

Digital Steam Sterilizer



Optimal's Electric sterilizer is designed to effectively remove milk residue from feeding utensils, ensuring the elimination of all harmful germs and bacteria that may come in contact with your child.

OPB - 1118	OPB - 1071
12 mins sterilization	9 mins sterilization
6 bottles	7 bottles
With accessories rack	With accessories rack
Tongue	Tongue
LED digital display	LED digital display
-	Red Light heat warning
Quiet operation	Quiet operation
Auto stop	Auto stop

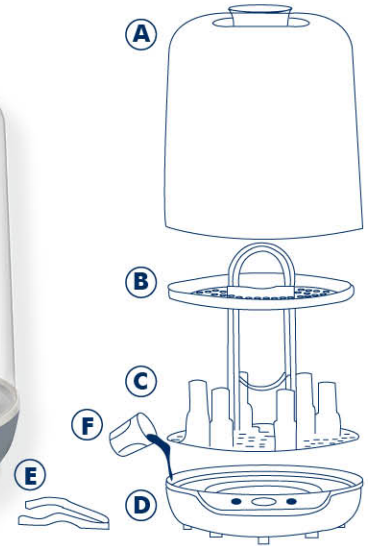

OPB - 1071

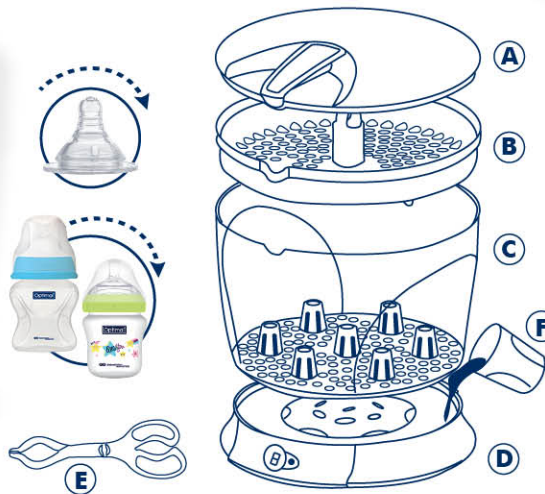

Direction of use:

- Remove the stainless steel base (D), measure water in the cup (F) and pour into base.
- Close the base with the bottle rack (C)
- Add feeding bottles (without their handles or teats)
- Place the accessory rack on top for teats and covers
- Close using the top/lid
- Turn on and wait till it automatically turns off
- After it cools down, remove the top part, and use the tong (E) to pull out the sterilized items.

Digital Steam STERILIZER & DRYER



STERILIZER



DRYER



DUAL MODE

OPB - 1140

OPB - 1140
10 mins sterilization
6 bottles
With accessories rack
Tongue
LED digital display
-
Quiet operation
Auto stop

Optimal Digital Steam Sterilizer & Dryer is a convenient and efficient solution for keeping your baby's feeding essentials clean, safe, and ready to use. Designed with advanced digital controls, it combines high-temperature steam sterilization with a powerful drying function to eliminate up to 99.9% of harmful bacteria without the use of chemicals.

Its spacious interior allows you to sterilize multiple baby bottles, nipples, pacifiers, and accessories in one cycle, while the intuitive touch panel ensures easy operation with preset sterilizing and drying modes.

Intended use	Icon	Default Time	Setting time range	water volume
Sterilize only		10 mins	Non	100 ml
Automatic Sterilize/Dry		50 mins	40-60 mins	100 ml
Dry Only		40 mins	20-60 mins	Non

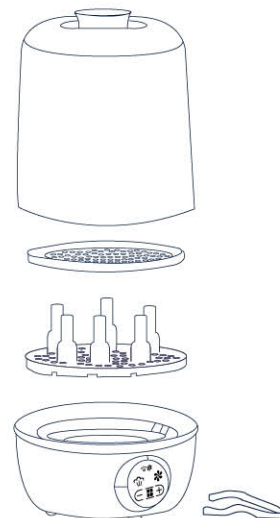

Baby Bottle Cleanser

Safely cleans baby bottles, nipples, accessories & toys

- Safe and effective
- Fragrance free
- Removes germs
- Eliminates milk odor
- Ideal to wash all baby items
- Ideal to wash fruits and vegetables



- The bottle cleanser contains enzymes that are highly effective in removing milk and food residue. It is the ideal choice for cleaning baby bottles, pacifiers, cups, and dishes, as well as breast pump parts, accessories, and washable toys..

USAGE INSTRUCTIONS

Add 1 dessert spoon (approx. 5ml) of product to 5L water. Wash and rinse with plenty of water.

WARNINGS

Causes serious eye irritation. Keep out of reach of children. Read the user instructions carefully. IF IN EYES: Rinse cautiously with water for several minutes. If eye irritation persists: Get medical advice. After washing, rinse your dishes with plenty of water. Wash your hands with plenty of water after use. Avoid contact with hands for long-term usage to protect the skin. Note: It contains Methylchloroisothiazolinone & Methylisothiazolinone, which may cause allergic reactions.



NON TOXIC



ALCOHOL FREE



PARABEN FREE



OPB - 1514

750 ml - 25.3 fl OZ





ACCESSORIES

Optimal provides everything you need to make those first precious months with your baby as comfortable and stress-free as possible. Our range includes safety covers, wipes, cotton, bath accessories, and more, all in one convenient location.

Pacifiers With Orthodontic Nipples

ORTHODONTIC NIPPLE SILICONE PACIFIERS WITH COVERS

ONE PIECE SILICONE PACIFIER WITH A FINGER HOLE DESIGN



OPB - 1442

+0m | Blister Card



OPB - 1442

+0m | Blister Card



OPB - 1443

+6m | Blister Card



OPB - 1443

+6m | Blister Card

Pacifiers With Round Nipples

ROUND NIPPLE SILICONE PACIFIERS WITH COVERS

ONE PIECE SILICONE PACIFIER WITH A FINGER HOLE DESIGN



OPB - 1444

+0m | Blister Card



OPB - 1444

+0m | Blister Card



OPB - 1445

+6m | Blister Card



OPB - 1445

+6m | Blister Card



Finger hole design

Fingers can be placed directly into the nipple hole to establish a closer parent-child relationship while soothing the baby's emotions.

Breathable flap
Anti-swallowing and breathable design complies with EU regulations

BPA free
Odorless, tasteless, non-sticky, does not contain plasticizers or bisphenol-A



Curved design
The curved design of the upper part can reduce the friction of the baby's nose and cause a red nose.

Food grade full silicone
Soft, skin-friendly and elastic, reducing friction on baby's face



Perforated ring design
The bottom is equipped with a perforated ring for easy use with pacifier chain

Pacifiers With Round Nipples

ROUND NIPPLE SILICONE PACIFIERS WITH COVERS

Optimal's pacifiers have a round shape design that creates enough space between the butterfly-shaped upper lip and the nose, allowing babies to breathe easily and comfortably.



Pacifiers With Orthodontic Nipples



ORTHODONTIC NIPPLE SILICONE PACIFIERS WITH COVERS

Orthodontic soother designed to help the baby's palate and teeth development.



DUST FREE SILICONE PACIFIER WITH COVER

Optimal's dust-free pacifiers are designed to provide convenience and hygiene for parents and their babies. Equipped with a self-closing shield, the pacifiers prevent germs and dirt from contacting the nipple when dropped, eliminating the need for frequent washing.

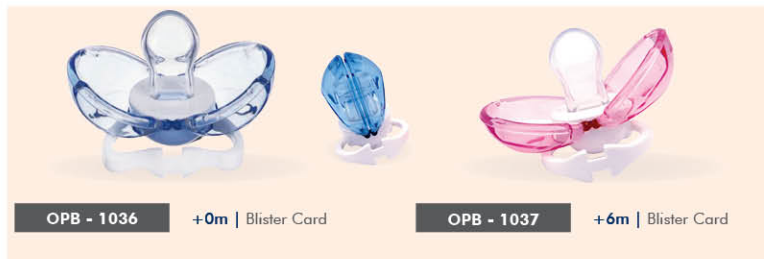

ORTHODONTIC NIPPLE SILICONE PACIFIERS WITH COVERS

Orthodontic soother designed to help the baby's palate and teeth development.

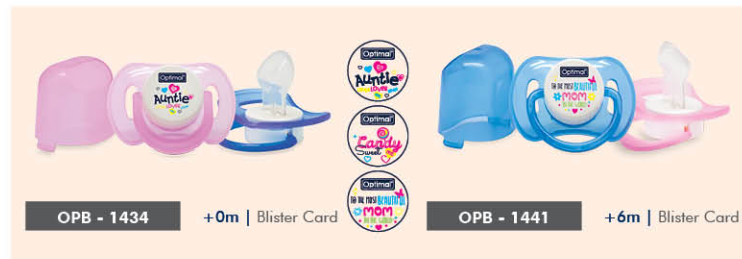

Pacifier Holders with Plastic Clip

Allow easy fastening to the baby's clothes. Helps keep the pacifier from falling.



OPB - 1042

+0m | Blister Card



+0m | Blister Card
Safety Metal Pin

OPB - 1212



OPB - 1069

+0m | Blister Card

Pacifier Holder with Metal Pin

OPB - 1044

+0m | Blister Card

Pacifier Holder With Plastic Clip



Rubber Frog Shape Baby Teether



4m+

OPB - 1002



3D



Safe Raw Material



Heat Resistant



Funny Frog Shape



Easy To Clean

Silicone Baby Teethers

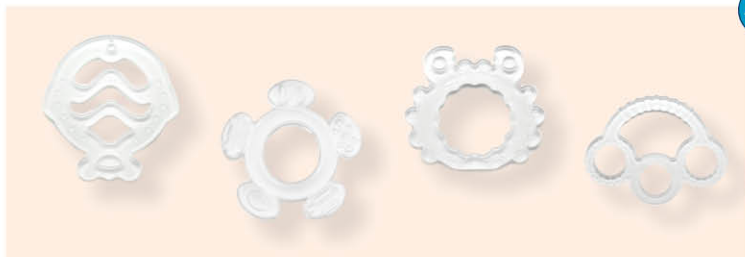

OPB - 1250

Multiple teething surfaces | Massage and stimulate gums

- Resistant to chewing and pulling.
- Suitable for 0-24 months baby to develop fine motor skills and improve hand-eye coordination
- Ribbed texture improves the baby's sensory development.
- Made from flexible food-grade silicone.
- Perfect size and shape, so that children do not suffocate

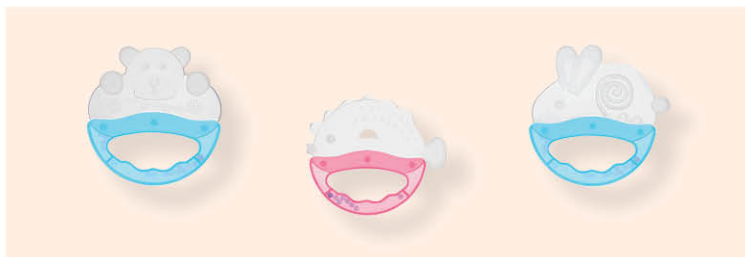

OPB - 1251

Multiple teething surfaces | Massage and stimulate gums

Funny Colored Water Teethers

Multi-color and shaped water-filled teethers massage the gums and reduce/relieve the pain of teething.



OPB - 1100



OPB - 1101



OPB - 1103

Refrigerator friendly! It can be cooled to provide more effective relief for the baby.

WATER FILLED TEETHER WITH PLASTIC HANDLE



OPB - 1040



OPB - 1104

Funny Colored Water Teethers

Multi-color and shaped water-filled teethers massage the gums and reduce/relieve the pain of teething.



OPB - 1119



OPB - 1120



OPB - 1121



OPB - 1122

Refrigerator friendly! It can be cooled to provide more effective relief for the baby.



OPB - 1123



OPB - 1124



OPB - 1125



OPB - 1126

Baby Silicone Toothbrush

Gently cleans, protects, and soothes teething gums



OPB - 0275

- Made of 100% food-grade silicone
- Soft on baby's gums
- With fine bristles for brushing baby's developing teeth and removing plaque for cavity prevention
- The round bumps help clean & massage baby's tongue
- Fits snugly on an adult index finger

Bottle & Nipple Cleaning Brush

Cleaning brush set includes two brushes one for the bottles and one for the nipples to provide better cleaning.

Brush Set For Cleaning
Bottles & Nipples



OPB - 1068

Rotary Cleaning Brush
With Nipple Brush



OPB - 1073

Nasal Accessories

Hygienically removes excess mucus from baby's nose.

Nasal Cleanser with Brushes



OPB - 1072



Silicone Nasal Aspirator



Pumps and gently
removes mucus with
minimal discomfort.

OPB - 1083



Baby Gift Set

• A perfect gift for all parents • Ideal for travel and nursery



OPB - 1075

Baby Nail Clippers & Scissors | Blister Card

Designed especially to clip the nails of newborns.



OPB - 1070



OPB - 1074



Cuts safely and precisely
Rounded tips | Anti-slip grip
Made of stainless steel With
protective cover

OPB - 1281

Safe Cotton Buds

NATURAL
Cotton

- Special safe design
- Made with the premium grade of cotton
- Flexible & soft paper stem



OPH - 057 108 Pieces



OPH - 056 80 Pieces



OPH - 055 55 Pieces



100 Pieces

OPH - 100



200 Pieces

OPH - 200



300 Pieces

OPH - 300

Baby Bath Sponge & Scrubber

0+
month

100%
Hypoallergenic
Tubed

Fast Rinse
Fast Drying

Extra
Soft

Soft texture is ideal for baby's sensitive skin.

Baby Bath Sponge



OPB - 1115

Bamboo Baby Bath Sponge



OPB - 1116

Baby Bath Sponge



OPB - 1099

Baby Bath Scrubber



OPB - 1113

Baby Bath Scrubbers



OPB - 1110



OPB - 1111



OPB - 1112

Milk Powder Dispenser

- Stackable containers for measuring powder in advance
- Each container closes separately • Ideal for home and travelling



OPB - 1137



OPB - 1056

Food Container

- Inner part can be removed.
- Divided into 3 parts.
- Dishwasher safe.



OPB - 1459

Wide Neck Food & Breastmilk Storage Cups

(2 pieces)



480ml Stainless Steel Vacuum Flask

Durable stainless steel construction keeps liquids hot or cold



OPB - 1135



OPB - 1136



Extra Soft Natural Bristles Brush & Comb Set

- 100% naturally soft hair • Especially for newborns • Ideal for particularly gentle combing and massage of the sensitive scalp • Suitable for daily use



OPB - 1082



Controllable,
to avoid spilling
on clothes or
wasting the
medicine



OPB - 0274

Delux Brush & Comb Set

- Extra soft nylon bristles for softly brushing and massaging the baby's scalp
 - Can be easily cleaned at up to 60°C, making it particularly hygienic
 - Small and lightweight with rounded edges.



OPB - 1054

Medicine Dropper & Feeder

5ml transparent silicone
plastic baby medicine
dropper



with measurement cup
Precisely feed the medicine



OPB - 1096

Mom & Baby Bags



OPB - 1222

- 36 x 28 x 15 cm
- With Shoulder Belt

OPB - 1224

- 35 x 28 x 15 cm
- With Shoulder Belt



Toiletry Bag



OPB - 1226

- 28 x 18 x 4 cm
- With additional pocket

Mom & Baby Backpack



- 27 x 42 x 21 cm
- With Shoulder Belt

This stylish backpack is perfect for daily use, with convenient partitions that make it ideal for both moms and dads. It has ample space to hold everything you need, making it a practical and fashionable choice for any occasion.



- Large capacity (internal multi-function partitions)
- Waterproof fabric

- Insulated 3 baby bottles pockets
- Keep liquids warm and cold for hours
- Easy feeding on the go

- Easily access items at the bottom of the bag
- Waterproof separate pocket for wet items
- Anti-theft hidden cell phone pocket



Tissue pocket



Easy to carry



Adjustable straps



3 Insulated Pockets

OPB - 1225

Baby Sensitive Wipes

Provide hygienic and practical cleaning | Alcohol free | Indicated for atopic skin



OPH - 077

Herbal Sensitive Wipes
(With Lid)



OPH - 076

Natural Baby Wipes
Aloe Vera * Licorice Root Extract
(With Lid)



OPH - 078

Powder Puff Sensitive
Baby Wipes
(With Sticker)



OPH - 079

Powder Puff Sensitive
Baby Wipes
(With Lid)



OPH - 072

Enriched With Vitamin E
And Aloe Vera
(With Sticker)



OPH - 073

Enriched With Vitamin E
And Aloe Vera
(With Lid)



OPH - 071

Pure Water Wipes
(With Lid)



- Skin-loving natural fibers
- Fragrance free
- Paraben free
- Sulphate free
- Alcohol Free

Baby Sensitive Wipes

Provide hygienic and practical cleaning | Alcohol free | Indicated for atopic skin

Baby Wipes Offers 3 in 1



OPH - 060

Refreshing Wipes
(With Lid)



OPO - 592

With Sticker



OPO - 535

With Sticker



OPO - 539

With Sticker



OPH - 061

Refreshing
Back to School Wipes
(With Lid)



OPO - 593

With Lid



OPO - 587

With Lid



OPO - 588

With Lid



Suprema
8PRO

BABY DIAPERS

Optimal Suprema 8 pro is designed to keep your baby's skin dry and healthy all day and night. Its absorbent mold wicks away moisture, and its highly absorbent particles lock wetness away from your baby's skin.

- **Advanced Absorbency:** The absorbent core wicks away moisture, keeping your baby's skin soft and dry.
- **Leak Protection:** Anti-leak guards help prevent messy leaks.
- **Flexible & adjustable:** Stretchy side panels and repositionable tabs provide a comfortable fit for your baby.
- **Soft material:** The cloth-like material is gentle on your baby's skin and helps keep them dry day and night.

PARAMETER			
Diaper Size	Baby's Weight	Quantity/Pack	Quantity/Value Pack
1 – NB	2 – 5 kg	24 diapers	48 diapers
2 – Mini	3 – 6 kg	24 diapers	48 diapers
3 – Midi	4 – 9 Kg	22 diapers	44 diapers
4 – Maxi	7 – 18 kg	20 diapers	40 diapers
4+ – Maxi Plus	9 – 20 Kg	20 diapers	40 diapers
5 – Junior	11 – 25 Kg	18 diapers	36 diapers
6 – XL	16+ Kg	16 diapers	32 diapers



OPB - 1702

Nº:2 | 3-6 kg | 24 diapers



OPB - 1701

Nº:1 | 2-5 kg | 24 diapers



OPB - 1703

Nº:3 | 4-9 kg | 22 diapers

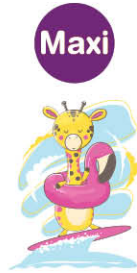

OPB - 1704

N°:4 | 7-18 kg | 20 diapers



OPB - 1705

N°:5 | 11-25 kg | 18 diapers

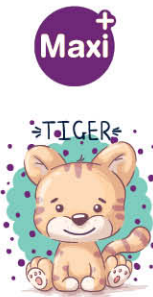

OPB - 1708

N°:4+ | 9-20 kg | 20 diapers



OPB - 1706

N°:6 | 16+ kg | 16 diapers

- **Advanced Absorbency:** The absorbent core wicks away moisture, keeping your baby's skin soft and dry.
- **Leak Protection:** Anti-leak guards help prevent messy leaks.
- **Flexible & adjustable:** Stretchy side panels and repositionable tabs provide a comfortable fit for your baby.
- **Soft material:** The cloth-like material is gentle on your baby's skin and helps keep them dry day and night.

PARAMETER			
Diaper Size	Baby's Weight	Quantity/Pack	Quantity/Value Pack
1 - NB	2 - 5 kg	24 diapers	48 diapers
2 - Mini	3 - 6 kg	24 diapers	48 diapers
3 - Midi	4 - 9 Kg	22 diapers	44 diapers
4 - Maxi	7 - 18 kg	20 diapers	40 diapers
4+ - Maxi Plus	9 - 20 Kg	20 diapers	40 diapers
5 - Junior	11 - 25 Kg	18 diapers	36 diapers
6 - XL	16+ Kg	16 diapers	32 diapers



NB



OPB - 1721

N°:1 | 2-5 kg | 48 diapers



Mini



OPB - 1722

N°:2 | 3-6 kg | 48 diapers



Midi



OPB - 1723

N°:3 | 4-9 kg | 44 diapers



Maxi



OPB - 1724

N°:4 | 7-18 kg | 40 diapers



Junior



OPB - 1725

N°:5 | 11-25 kg | 36 diapers



Maxi+



OPB - 1728

N°:4+ | 9-20 kg | 40 diapers



X Large



OPB - 1726

N°:6 | 16+ kg | 32 diapers



OPB - 1727

N°:7 | 19+ kg | 30 diapers

Suprema 8 PRO GIANT PACKS BABY DIAPERS

PARAMETER			
Diaper Size	Baby's Weight	Quantity/Value Pack	Quantity/Giant Pack
2 - Mini	3 - 6 kg	48 diapers	192 diapers
3 - Midi	4 - 9 Kg	44 diapers	176 diapers
4 - Maxi	7 - 18 kg	40 diapers	160 diapers
4+ - Maxi Plus	9 - 20 Kg	40 diapers	160 diapers
5 - Junior	11 - 25 Kg	36 diapers	144 diapers
6 - XL	16+ Kg	32 diapers	128 diapers



OPB - 1742



4 x 48 Diapers

N°:2 | 3-6 kg | 192 diapers



OPB - 1743



4 x 44 Diapers

N°:3 | 4-9 kg | 176 diapers

Maxi



OPB - 1744



4 x 40 Diapers

N°:4 | 7-18 kg | 160 diapers

Junior



OPB - 1745



4 x 36 Diapers

N°:5 | 11-25 kg | 144 diapers

Maxi+



OPB - 1748



4 x 40 Diapers

N°:4+ | 9-20 kg | 160 diapers

X Large



OPB - 1746



4 x 32 Diapers

N°:6 | 16+ kg | 128 diapers

- **Advanced Absorbency:** The absorbent core wicks away moisture, keeping your baby's skin soft and dry.
- **Leak Protection:** Anti-leak guards help prevent messy leaks.
- **Flexible & adjustable:** Stretchy side panels and repositionable tabs provide a comfortable fit for your baby.
- **Soft material:** The cloth-like material is gentle on your baby's skin and helps keep them dry day and night.

PARAMETER

Diaper Size	Baby's Weight	Quantity/Pack	Quantity/advanced Pack
2 – Mini	3 – 6 kg	24 diapers	144 diapers
3 – Midi	4 – 9 Kg	22 diapers	132 diapers
4 – Maxi	7 – 18 kg	20 diapers	120 diapers
5 – Maxi +	9 – 20 Kg	20 diapers	120 diapers
5 – Junior	11 – 25 Kg	18 diapers	108 diapers
6 – XL	16+ Kg	16 diapers	96 diapers

Mini



OPB - 1752

6 x 24 Diapers

N°:2 | 3-6 kg | 144 diapers

Midi



OPB - 1753

6 x 22 Diapers

N°:3 | 4-9 kg | 132 diapers

Maxi



OPB - 1754

6 x 20 Diapers

N°:4 | 7-18 kg | 120 diapers



Maxi⁺



OPB - 1758



6 x 20 Diapers

N°:4+ | 9-20 kg | 120 diapers

X Large



OPB - 1756



6 x 16 Diapers

N°:6 | 16+ kg | 96 diapers

Junior



OPB - 1755



6 x 18 Diapers

N°:5 | 11-25 kg | 108 diapers





FEEDING PRODUCTS

As your child grows and reaches important developmental milestones such as walking, climbing, running, and communicating, their nutritional needs will change as well.

This is where feeding sets come in. With some basic knowledge, you can discover the best ways to nourish your child starting from birth.

Table-ware feeding sets



4m+ OPB - 1008



Grinding Feeding Bowl With Spoon

Specially designed to grind soft fruits and vegetables. Dishwasher safe.



4m+ OPB - 1009

Non-Slip Feeding Dish With Soft Tip Spoon



4m+ OPB - 1014

Solid Body Feeding Plate With Soft Tip Spoon



4m+ OPB - 1010



Flexible silicone Spoon & Fork



4m+ OPB - 1012



6m+ OPB - 1043

Silicone Baby Bib

100% Safe | Adjustable Neckband | Wide Pocket



4m+ OPB - 1129



OPB - 1130

Silicone Squeeze Feeder

Food grade silicone, soft and transparent bottle for easy feeding.



Gently squeeze the silicone base until the desired amount of food collects on the spoon



Safe for baby's health, the cover prevents leakage and dust

4m+ OPB - 1057

Baby Food Feeder

The innovative design of our product allows only tiny pieces of food to pass through, providing optimal safety for your baby.



4m+ OPB - 1127



100% food-grade silicone

With a dust cover

Easy to clean with a safety lock

Ergonomic Handle

6m+ OPB - 1128

Tritan silicone straw cup

Tritan is known for its strength, clarity, and safety.



12m+ OPB - 2017

550 ml



12m+ OPB - 2018

650 ml



2 in 1 Tritan spout and straw cup



12m+ OPB - 2019

550 ml



12m+ OPB - 2020

650 ml



Tritan spout cup

Tritan is known for its strength, clarity, and safety.



24m+



24m+ OPB - 2021

450 ml



24m+ OPB - 2022

540 ml



24m+ OPB - 2023

600 ml



24m+ OPB - 2024

750 ml



24m+ OPB - 2025

780 ml

Drinking Cups with silicone straw & spout

Helping little ones drink on their own



12m+



Swivel Head

220 ml

12m+ OPB - 1053



400 ml

12m+ OPB - 2014



260 ml

12m+ OPB - 1086



350 ml

12m+ OPB - 2012



350 ml

12m+ OPB - 2008



500 ml

12m+ OPB - 2009

Water Cups with silicone spout

Helping little ones drink on their own



12m+



240 ml

12m+ OPB - 1084



240 ml

12m+ OPB - 2006



350 ml

12m+ OPB - 2007



300 ml

12m+ OPB - 1085

Dual Use Water Cup



380 ml

12m+ OPB - 2016

Baby Trainer Cup - 360°



320 ml

9m+ OPB - 2015

Soft alternative spouts



12m+ OPB - 1169



12m+ OPB - 1173

Stainless Steel Water Bottles



- Knobby surface for a non-slip grip
- Spill-proof soft spout



(A)
PINK FARM



(B)
NEW YORK



(C)
LADYBUG



(D)
DINOSAUR



(E)
BLUE FARM



(F)
JUNGLE



(G)
CLOUDS



(H)
UNDERWATER

OPB - 2010 350 ml



(I)
RACING CAR



(K)
WHALE



(M)
SPORT



(J)
KASHMIR



(L)
LADYBUG



(N)
PRINCESS

OPB - 2013 450 ml



Stainless Steel Bottle is made of high quality, food grade, stainless steel. It has a soft pop-up spout. The cap helps keep spout clean. Durable and Dishwasher safe.

Note:

- Please wash before use with special detergent. | • Do not scrub the surface with hard bristles to avoid scratches.
- If damaged update immediately. | • Avoid baby chewing. | • Keep it away from fire and collision.

Display Box



SKINCARE



Since your baby's skin is delicate and sensitive, taking proper care of it is crucial. Luckily, the best tips for baby skin care are often the easiest to follow.

300ml Baby Toiletry Products

Sensitive Touch to your Baby's skin



OPB - 1501



OPB - 1509



OPB - 1510



OPB - 1511



OPB - 1502

Extra Soft Formula



OPTIMAL® Skin care products with its ultra-soft formula, gently cleans hair of babies and children. Hypoallergenic, suitable for atopic skin and for newborns. Thanks to its physiological PH, it respects the cutaneous balance of the scalp. If does not itch in the eyes, it can be used every day to help keep your baby's skin and hair soft and smooth.

Tested on sensitive and reactive skin. Dermatologically and ophthalmologically tested. Alcohol free, perfume allergens free.

Paraben, phtalate, alcohol, phénoxyéthanol 0%



SPRAY SUNSCREEN (SPF 50+) - 250 ml

OPB - 1505



SUNSCREEN (SPF 50+) - 250 ml

OPH - 1606



SUNSCREEN (SPF 50+) - 125 ml

OPB - 1515



TRAVEL KIT SPF 50+

75 ml x 2

OPB - 1508



NAPPY CHANGE CREAM

• Perfect for Newborns

100 ml

OPB - 1512



DENTAL CARE

A gentle care for little smiles. Optimal Bio Strawberry Toothpaste is specially formulated for little ones aged 1 to 6 years old, combining the delicious taste of strawberries with natural origin ingredients



99% OF NATURAL ORIGIN INGREDIENTS

TODDLER Toothpastes

- Sugar Free
- 99% Of Natural Origin Ingredients
- Without Fluoride
- Pleasant strawberry flavor
- Protects and strengthens little teeth



OPB - 1550

Net wt 65.5grs.



Crafted with care, this toothpaste is free from synthetic colorings and flavorings, ensuring a safe and gentle brushing experience. It helps to clean and protect delicate teeth and gums while being kind to sensitive mouths.

PRECAUTIONS FOR USE: Do not use for children under 1 year of age | Do not swallow | Use under adult supervision.

INGREDIENTS: Sorbitol, Mentha Piperita Leaf Water, Hydrated Silica, Aqua, Xylitol, Aloe Barbadensis Leaf Juice, Lauryl Glucoside, Xanthan Gum, Aroma, Sodium Benzoate, Stevia Rebaudiana Extract, Citric Acid, Potassium Sorbate, Maltodextrin, Mentha Piperita Oil, Menthol, CI 75470.

TODDLER Toothpastes

- Sugar Free
- 99% Of Natural Origin Ingredients
- Without Fluoride
- Pleasant strawberry flavor
- Protects and strengthens little teeth



OPB - 1551

Net wt 65.5grs.



Crafted with care, this toothpaste is free from synthetic colorings and flavorings, ensuring a safe and gentle brushing experience. It helps to clean and protect delicate teeth and gums while being kind to sensitive mouths.

PRECAUTIONS FOR USE: Do not use for children under 1 year of age | Do not swallow | Use under adult supervision.

INGREDIENTS: Sorbitol, Mentha Piperita Leaf Water, Hydrated Silica, Aqua, Xylitol, Aloe Barbadensis Leaf Juice, Lauryl Glucoside, Xanthan Gum, Aroma, Sodium Benzoate, Stevia Rebaudiana Extract, Citric Acid, Potassium Sorbate, Maltodextrin, Mentha Piperita Oil, Menthol, CI 75470.



BABY BATH ACCESSORIES

Optimal offers a range of baby bath accessories that ensure your baby's bath time is safe and enjoyable.

Our products are thoughtfully designed to provide comfort and convenience for both baby and parent. With our carefully researched and insightfully designed bath accessories, bath time can become a happier and stress-free experience.

Egg-shaped Baby Bathtub With A Back Support

- Safe PP Material
- Product dimensions: 27 x 31 x 25 cm
- Equipped with an anti-slip bottom.
- Detachable Back Support
- Features a narrow and deep insulated bottom to maintain warmth for a longer period.

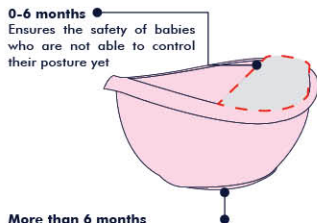

0-6 months
Ensures the safety of babies who are not able to control their posture yet

More than 6 months
Babies who have developed back strength and can sit up without support may use the bathtub without the backrest.

0 m+

OPB - 1215



Available colors

Baby Bathtub With Anti-Slip EVA Pads

- Material: PP + EVA
- Product dimensions: 30 x 36 x 26 cm
- Helps prevent the baby from sliding into the water
- Features EVA foam base and backrest for added comfort
- Suitable from birth up to 12 months
- Easy water drainage from the tub using the drain plug



OPB - 1216



Available colors



Safe PP Material



Non-Slip Base



Thick Insulation

Baby Bathtub With With Anti-Slip Recline Pad

- Material: PP + EVA
- Suitable from birth up to 36 months
- Non-slip seat and back support
- Compact size for easy storage and travel
- Easy water drainage from the tub using the drain plug

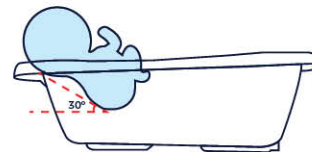

0-6 months reclined bath mode

OPB - 1217



Available colors

The bathtub is divided into two parts: the reclined side is for young babies who are not able to control their posture yet, while the other part is recommended for babies who have developed enough back strength to sit up without support. For easier water drainage, the bathtub includes a built-in drain plug.

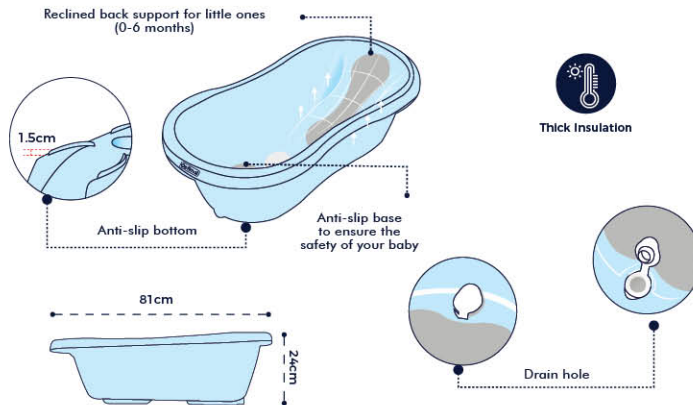

Changing table with bath tub

Adapt From 3 To 11 Kgs



0 m⁺

Age suitability: Birth to 12 months approx.
Size: H: 101 x W: 97 x D: 62cm approx.

The baby changing table with built-in bathtub offers a convenient and practical solution for parents.

Features:

- A large bathtub designed for the baby's comfort during bathing.
- Storage tray to keep bath essentials within reach.
- Folding design that allow the unit to be easily stored when not in use.
- Durable and waterproof materials for easy cleaning.
- Additional storage space with drawers to store diapers, towels, and other baby care items.



OPB - 1203

Changing Mat

• Suitable From Birth • Waterproof Mat • Easy To Wipe Clean

Changing pad measures 80 x 47 x 6 cm and is recommended for use up to 13Kgs.

100% Non-allergenic Foam & Cover

- Made of the best quality materials
- Do not irritate skin
- Easy to keep clean
- For beds, tables, chest of drawers etc...



0 m⁺

OPB - 1207

Non-Slip Cushion Sponge



OPB - 1114

0 m⁺

OPB - 1239



Soft Potty Seat With Handle



- Material: PVC
- Potty seat size: 33.5x33.5x15cm
- Suitable for children and babies from 1 to 5 years old
- Suitable Weight: up to 14kg
- Lightweight and easy to carry
- An intimate design of anti-splash urine shield to prevent urine from spilling
- A higher backrest to help your kids feel more comfortable
- The PU cushion enhances the comfort level
- Our potty training seat fits all standard toilets

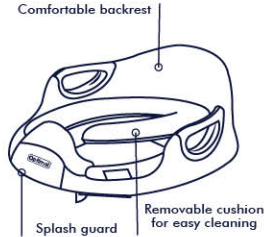

OPB - 1218



Soft Potty Seat With Handle



- Material: TPE
- Potty seat size: 35x39.5x16cm
- Suitable for children and babies from 1 to 5 years old
- Suitable Weight: up to 14kg
- Lightweight and easy to carry
- An intimate design of anti-splash urine shield to prevent urine from spilling
- A higher backrest to help your kids feel more comfortable
- The PU cushion enhances the comfort level
- Our potty training seat fits all standard toilets

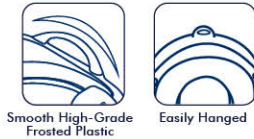

Smooth High-Grade Frosted Plastic

Easily Hinged



High Quality Soft Cushion

OPB - 1219



Soft Potty Seat With Handle

Ideal for home and traveling

Assist your child to become familiar with regular toilet facilities while protecting him from the discomfort of slipping into the toilet during the early stages of toilet training.

- Detachable seat padding
- Splash guard
- Soft and Wipeable
- Cushioned for comfort
- Contoured for safety
- Deep rim for stability
- Hygienic lifting handle
- Fits all toilet seats
- Non-slip rubber coating



OPB - 1214



2-Step Stool with Non Slip Base for Kids

- Material: PP+ TPE
- Ideal Height for Potty Training
- Boost your kid's independence
- Easy to Clean
- Fast Installation
- Sturdy And Secure
- Non Slip Surface & Base
- Stool Size: 25x37x33cm.
- Max. Load: 70kg

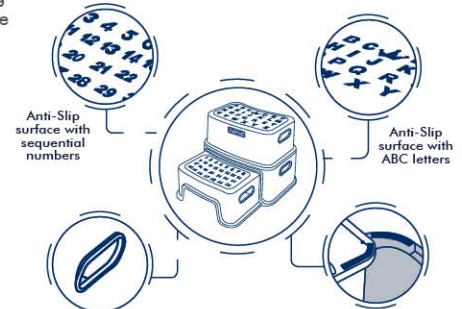

OPB - 1220





BABY CARRIERS

Optimal baby carrier is designed to secure the baby close to the body, allowing the adult to carry the child while having their hands free for other tasks. Baby carriers come in various styles, each offering different features and benefits. These carriers provide a comfortable and secure way to transport babies while promoting bonding between parents and baby.

Ergonomic Baby Carriers



OPB - 1230



The soft, cushioned panels ensure your little one can enjoy a comfortable ride by providing a gentle and supportive surface. The padded straps and ergonomic design are intended to distribute the child's weight evenly across your body, reducing strain and providing added comfort while carrying your little one.

Safe baby carrier with 3 positions for a complete freedom



Baby Facing Out



Baby Facing In



Backpack Position



OPB - 1231



The soft, cushioned panels ensure your little one can enjoy a comfortable ride by providing a gentle and supportive surface. The padded straps and ergonomic design are intended to distribute the child's weight evenly across your body, reducing strain and providing added comfort while carrying your little one.

Safe baby carrier with 3 positions for a complete freedom



Baby Facing Out



Baby Facing In



Backpack Position

Ergonomic Baby Carriers



3+
MONTHS
15KG

OPB - 1232

The soft, cushioned panels ensure your little one can enjoy a comfortable ride by providing a gentle and supportive surface. The padded straps and ergonomic design are intended to distribute the child's weight evenly across your body, reducing strain and providing added comfort while carrying your little one.

Safe baby carrier with 3 positions for a complete freedom



Baby Facing Out



Baby Facing In



Backpack Position

Adjustable Safety Harness For Baby Walking



OPB - 1233

6 Months to 13kg

No tugging and twisting on little arms and fewer falls. We recommend using it with a onesie or shirt to avoid any rubbing on the skin.

- Reduces back pain from bending over for parents and grandparents.
- Builds confidence and stability for the baby and gives him a sense of walking while preserving his safety
- The handheld baby walker harness is made of polyester, a built-in soft breathable sponge, soft hand feeling, strong air permeability, and is super durable.



Lightweight



Skin Friendly





ON THE MOVE

Optimal Baby gear offers maximum comfort and convenience for your child's safety and security. Our baby car seats and strollers are designed with an ergonomically shaped handle that ensures a comfortable carrying position for parents. With our products, you can be sure that your baby is safe and secure while on the move.

Car Seats

OPB - 1200

- Group 0+
- Adapt from 0 to 13kgs
 - Up to 76cm tall



OPB - 1221

- Group 0+ ,1
- Adapt from 0 to 13kgs
 - Up to 82cm tall



OPB - 1202

- Group 0, I, II
- Adapt from 0 to 25kgs
 - From 0 to 6 years



Compatible with a stroller and a mom bag



OPB - 1223

Baby Stroller With Basket

• Ultra-Light Aluminium Frame • 0 - 4 years • Adapt to 22kgs



Baby Stroller With Basket

• Ultra-Light Aluminium Frame • 0 - 4 years • Adapt to 22kgs

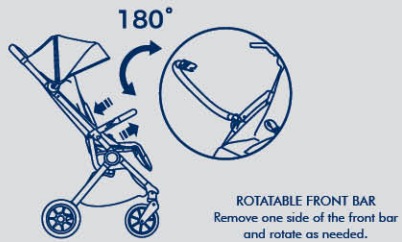

LEG-REST ADJUSTMENT
Pull the adjusting device below the leg-rest to adjust the angle of the leg-rest up and down.

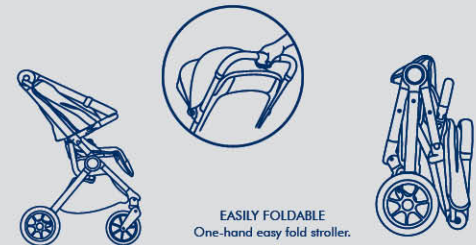

Baby Stroller With Basket

- Ultra-Light Aluminium Frame • Stroller Group 0, I • Adapt to 15kgs



OPB - 1208



Baby Stroller with basket

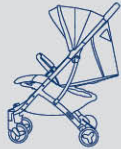

Can be Sitting & lying
Provide a good environment for baby to sleep



4 Wheels suspension with precision swivel front wheels let you push it anywhere

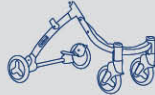

Easier to Control, you can save up more of your energy with these 12 bearings

Baby Stroller Set 2 in 1 with basket

- Pushchair + carrycot • Stroller Group 0, I • Adapt to 15kgs



OPB - 1209

Compatible with a car seat and a mom bag



OPB - 1223

Musical Baby Walker

From 6 to 18 months

- Large musical toy tray
- 6 wheels
- 3 heights adjustment settings for a customized ride
- Wide base for superior stability
- Comfortable and easy to clean cushion
- Easily foldable for travel or storage
- Not intended for children who can walk by themselves or weigh more than 12 kgs.
- Meets the European standard EN71-1-2-3



Glide smoothly



Easy to fold



Adjustable
height



Easy
Cleaning



OPB - 1211

Multifunctional High Chair

FROM 6 MONTHS TO 3 YEARS | UP TO 20 KGS



Available in 3 colors:



INCLUSIONS

- 2 IN 1 CHAIR
- 5-POINT SEAT BELT & SOFT CUSHION
- ADJUSTABLE & REMOVABLE TRAY
- SAFE & STURDY DESIGN
- EASY TO ASSEMBLE
- LARGE STORAGE BAG

- The baby high chair is suitable for ages 6 months to 3 years; you can quickly disassemble the legs of the HIGH chair and convert it into a low chair perfect for playtime or you can use it according to your actual need.
- For extra safety and comfort, the 5-point seat belt can be adjusted to the perfect fit while the soft cushion is breathable, detachable, and wipeable
- The independent food tray has 3 adjustable positions to keep the baby in the most comfortable state and can be removed directly for easy cleaning.
- Environmentally friendly PP plate, BPA-free, quality assured tray makes your baby totally relaxed.
- Removable pocket, where toys, bottles, towels, etc. can be stored.

OPB - 1204

Foldable Multifunctional High Chair

FROM 6 MONTHS TO 3 YEARS | UP TO 20 KGS



Available in 3 colors:



Adjustable
Backrest



Foldable
High Chair

INCLUSIONS

- 2 IN 1 CHAIR
- FOLDABLE LEGS
- ADJUSTABLE BACKREST
- 5-POINT SEAT BELT & SOFT CUSHION
- ADJUSTABLE & REMOVABLE TRAY
- SAFE & STURDY DESIGN
- EASY TO ASSEMBLE
- LARGE STORAGE BAG

- The baby high chair is suitable for ages 6 months to 3 years; you can quickly disassemble the legs of the High chair and convert it into a low chair perfect for playtime or you can use it according to your actual need.
- For extra safety and comfort, the 5-point seat belt can be adjusted to the perfect fit while the soft cushion is breathable, detachable, and wipeable
- The independent food tray has 3 adjustable positions to keep the baby in the most comfortable state and can be removed directly for easy cleaning.
- Environmentally friendly PP plate, BPA-free, quality assured tray makes your baby totally relaxed.
- Removable pocket, where toys, bottles, towels, etc. can be stored.
- Foldable legs for easy storage and portability.
- Adjustable backrest to support multiple reclining positions for comfort and feeding.

OPB - 1205

Baby Care display



AVAILABLE DIMENSIONS: 60 x 200 cm | 80 x 200 cm | 100 x 200 cm

Cups display



AVAILABLE DIMENSIONS: 50 x 200 cm | 85 x 200 cm

Skin Care products double sided



Skin Care products one sided



AVAILABLE DIMENSIONS: 40 x 150 cm

UNIMARC 

OPTIMAL **Medics s.a.r.l.**
Health Care Products

Distributed by:

UNIMARC S.A.R.L.

Head Office:

Bd des Eplatures 64, 2300 La Chaux-de-Fonds, Switzerland

Tel: +41 762 906 320, E-mail: info@unimarc.ch

Website: www.unimarc.ch

OPTIMAL MEDICS S.A.R.L.

Head Office:

Horizon Building, Doha Entrance, Choueifat, Lebanon

Mob: +961 70 555 445, Tel: +961 5 812 850

E-mail: info@optimalmedics.com, Website: www.optimalmedics.com



Visit us on:



Optimal



Optimal_medics